

Investigation on Fault Analysis for Power Transformers Using Adaptive Differential Relay

C. Nagarajan¹, G. Neelakrishnan², R. Janani³, S. Maithili⁴ and G. Ramya⁵

¹Professor and Head, ²Assistant Professor, ^{3,4&5}UG Student,
Department of EEE, Muthayammal College of Engineering, Rasipuram, Tamil Nadu, India
E-mail: nagaraj2k1@gmail.com

(Received 4 November 2021; Revised 13 December 2021; Accepted 12 January 2022; Available online 19 January 2022)

Abstract - This article presents the fault analysis and differential protection scheme of the three phase Power Transformers (PT). The relay operates mainly during the internal fault condition and it must be insensitive to any fault outside the zone of protection. In this paper, a fuzzy logic based differential protection schemes has been used. It blocks the tripping through outer fault and internal fault conditions. The simulation result of FLC with disparity relay for 3 phase transformer shows fast tripping during internal fault and also avoids the mal operation of relay during external fault.

Keywords: Circuit Breaker, Differential Relay, Fuzzy Logic Controller, Mat Lab, Power Transformer, Transmission Line

I. INTRODUCTION

PT (Power transformers) is the most important mechanism in a transmission line. So they require proper analysis and protection during faults period to avoid PT damage [1]. For economic and reliable operation of power supply to the consumer needs proper protection methods. The fast tripping during faults and more reliable which separates the internal faults, external faults and other operating condition (like magnetic inrush current, CT saturation [2]). On the other hand, the protection schemes to avoid mal function or

false tripping during faults occurred out of the protection zone [3].

Differential safety is supported to the fact at any fault in electrical component would source the current incoming is different and leaving. Thus examine the two currents both in value and in section or both and difficulty a trip output if the distinction exceeds a predetermined set fee value. In current trends developed technology toward progressed sensitivity, selectivity, and time of operation has been offered to conquer the associated problems. But it requires massive data's and working time is greater. In this article an developed FLC with differential relay is proposed that's capable of differentiating between internal and external faults, reduced tripping time, magnetizing inrush current [4], [5]. Developed protection method is fast of circuit breaker after the elimination of fault.

II. PRINCIPLE OF DIFFERENTIAL RELAY

The Block Diagram of Differential Relay as presented in Figure 1 is based on differenced with primary and secondary current in windings [6].

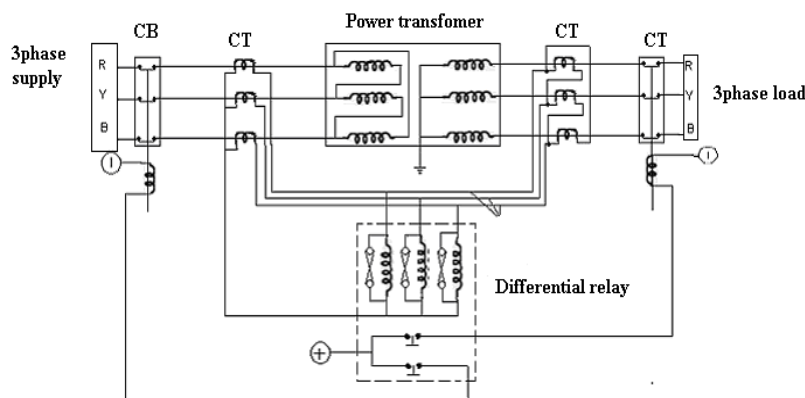

Fig. 1 Block Diagram of Differential Relay

During the normal operating condition, the current I_1 enters the primary winding and I_2 leaves the secondary winding of the transformer must be equal. If any unbalances are encountered in between both the currents which are due to the faults, the transformer currents are different. The relay has been activate and produced signals to the breaker to the transformer [7].

III. FUZZY RULE BASED DIFFERENTIAL RELAY

The block diagram of Differential relay based on Fuzzy System is presented in Figure 2. The current transformer data is taken as first data. By using this data the degree of difference currents are designed.

The I_d (differential current) is from,

$$I_d = I_1 - I_2$$

Primary and secondary currents are compared by using the differential relay. If found any unrelated data, the signal is send to FLC [8, 9]. The FLC is developed to create a

difference between inner faults and additional operating conditions of transformer. The desired output value is high compared to set value, the relay cutoff the breaker. The trip choice is based upon the qualified amplitude signals to the fundamental current module evaluated to apparatus of differential output signal [10].

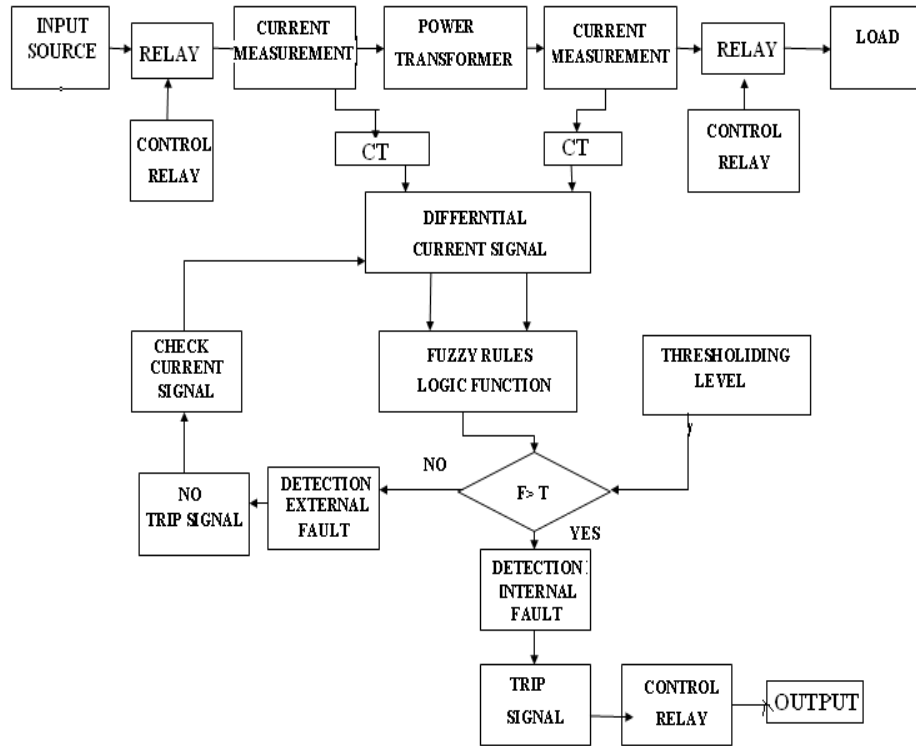

Fig. 2 Block Diagram of Differential relay Based on Fuzzy System

The developed FLC based nine rules to differentiate between inner faults and previous operating setting to create a difference between two effective conditions i.e.,

1. SS (Steady state)
2. Inner faults.

The nine FLC inference rules be classified in to 3 categories depends on input variable. In table I represents the FLC values. “L” is Low, “M” is Medium, “H” is High, “SS” is Steady, “F” is Fault.

TABLE I INPUT VARIABLE

I ref	I dif	O/P	Trip
L	L	SS	OFF
L	M	SS	OFF
L	H	SS	OFF
M	L	F	ON
M	M	F	ON
M	H	SS	OFF
H	L	F	ON
H	M	F	ON
H	H	F	ON

Input variable 1 indicating as low value in primary side is shown Figure 3.

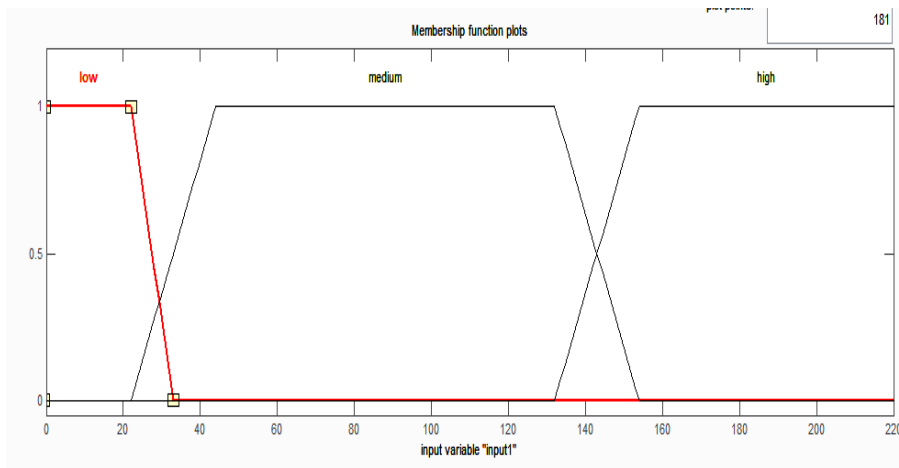

Fig. 3 I/P Variable 1

Input variable 2 indicating as low value in the secondary side is shown Figure 4.

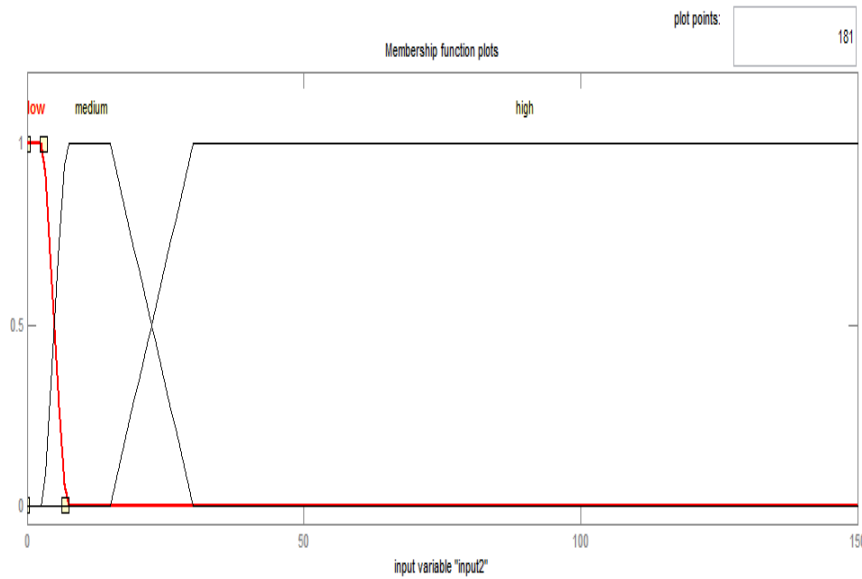

Fig. 4 I/P Variable 2

Both the input variables are low to the transformer and the output has the steady valves is shown in Figure 5.

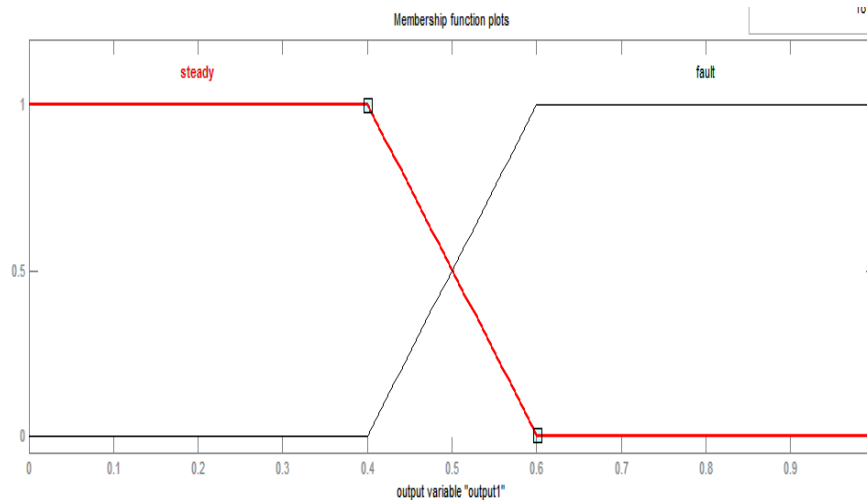

Fig. 5 O/P Variable

IV. SIMULATION RESULTS

In this paper, for purpose of analysis 200MVA, 50Hz, Delta/Star connected Three phase transformer is used [11], [12]. The results are discussed with 2 cases. Study I: the Fault within the inner fault. The fault arise in transmission line within the protection zone, if the differential current acquire

from primary current and secondary current is increased above threshold value is 0.55, the FIS system gives the control signal to relay to trip the circuit breaker. After clearing the fault, circuit breaker auto-reclosing the circuit and give the supply to the load [13], [14] & [15]. The output waveform of Fuzzy Inference System is shown in Figure 6.

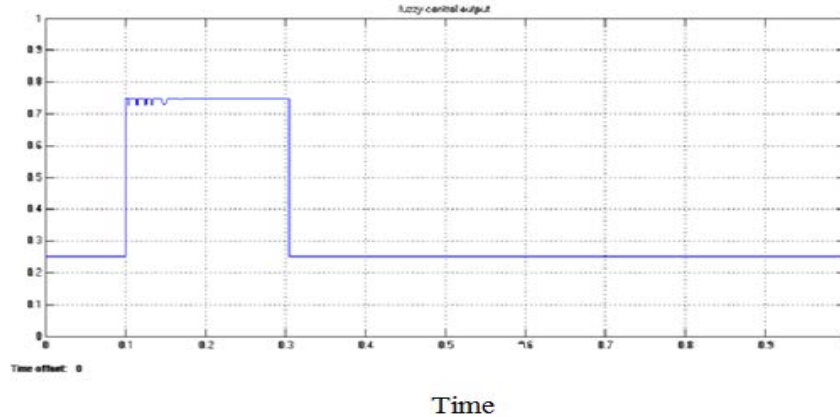

Fig. 6 Output Waveform of FIS System

After receiving the signal from FIS system, then the relay send the signal to control breaker during the inner fault from the period of 0.1ms to 0.33ms as shown in Figure 7. It is concluded that the relay output signal is protected. After that the fault clearing period the relay auto reclosed and give the supply to the load. The total output current waveform of

fuzzy based differential relay as shown in Figure 8. During the faults period 0.1ms to 0.33ms the relay in turnoff period, that means the input does not give the load. After that the fault cleared, the relay auto-reclosed and gives the supply to the load from period of 0.33ms.

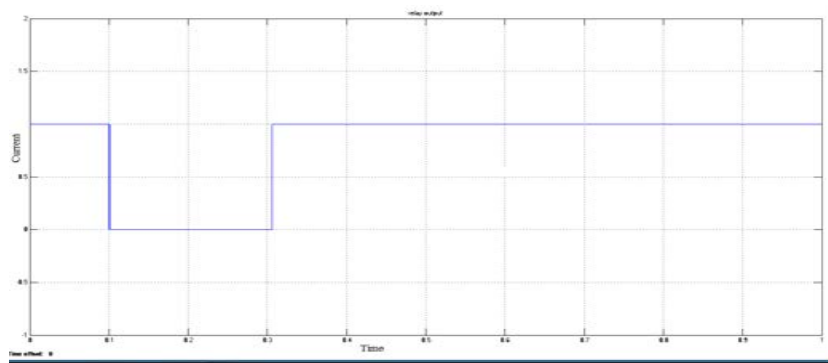

Fig. 7 Output Waveform of Differential Relay

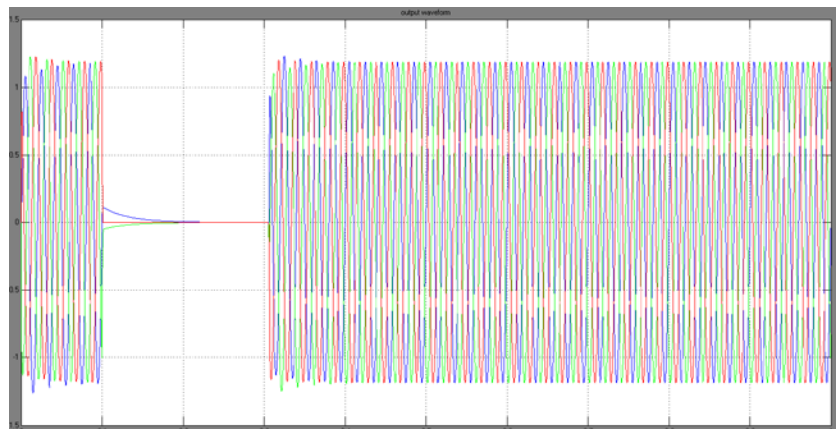

Fig. 8 Output Current Waveform

The total PQ output power during the fault condition the as the output power to the load is nil. in the Figure 9, it shows from the period of 0.1ms to 0.33ms

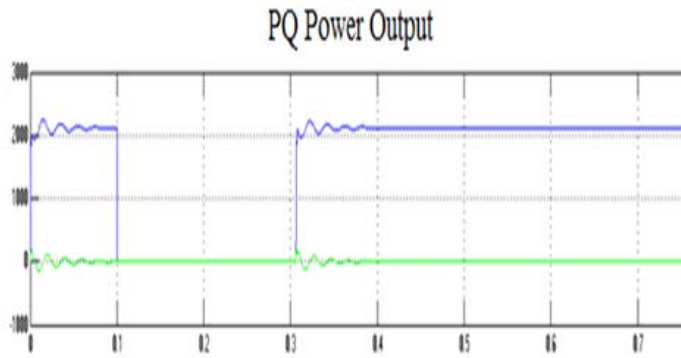

Fig. 9 Output Power Waveform

Study II: External Faults (Out of protection zone) are faults accrued in the outside of the proposed system. The FIS is the better differential relay in external under fault condition.

Relay is tested on all external faults [18], [19]. Simulation results of the proposed system are presented in Fig 10 under outside fault condition [20].

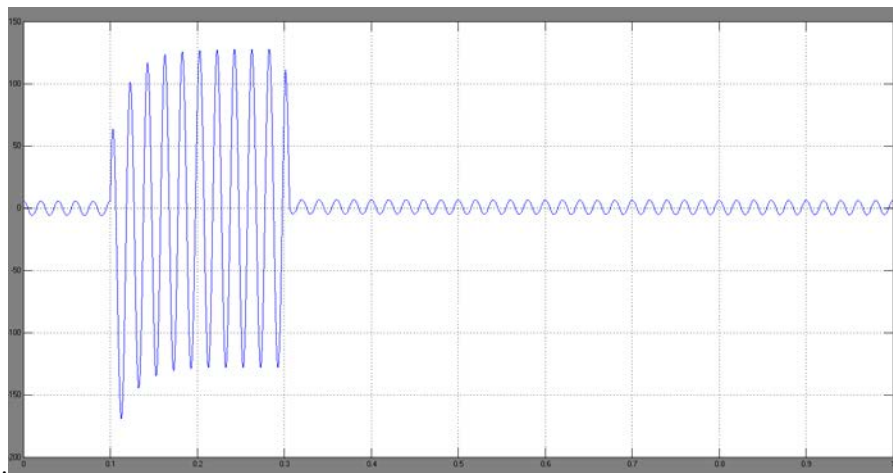

Fig. 10 Phase A-G External Fault

In the current during the transformer operating period of 0.1 to 0.3 under external fault, in this period, differential relay should not provide the tripping signal to breaker. So that the fuzzy control avoid the false tripping of relay from the fault

outside the protective zone. The simulation output waveform of phase B-G as shown in Figure 11 during external fault condition.

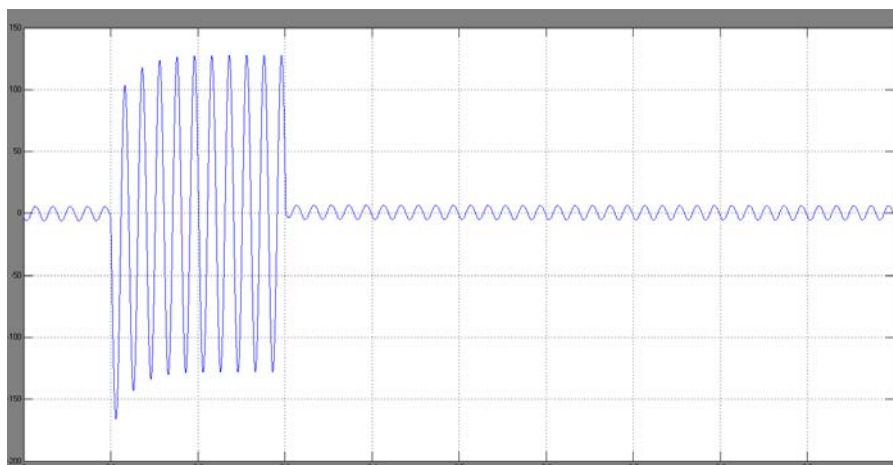

Fig. 11 Phase B-G External Fault

Simulation result for phase C-G as shown in Figure 12, the line current is high during an external fault condition the

designed relay signals but it does not give the tripping signal, so the relay is more sensibility and reliability.

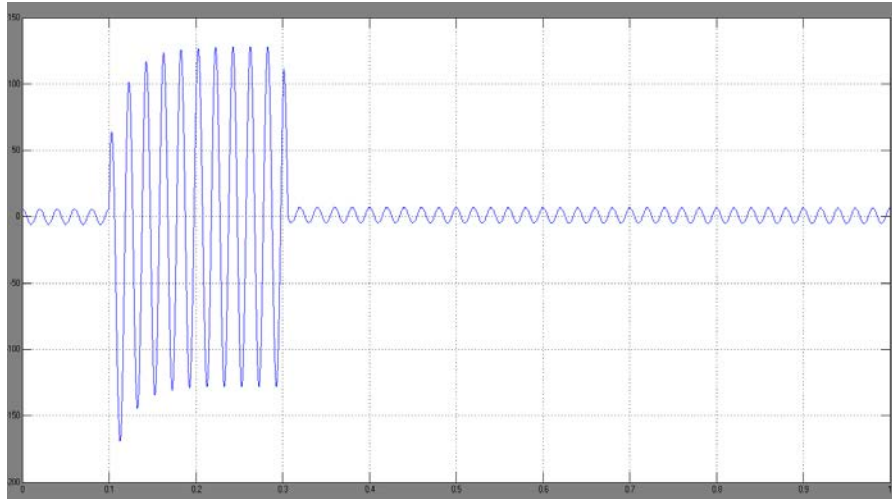

Fig. 12 Phase C-G External Fault

The fuzzy inference procedure as presented in Figure 13. Input 1 is indicated as primary currents of power

transformer and Input 2 indicated as secondary currents of power transformer.

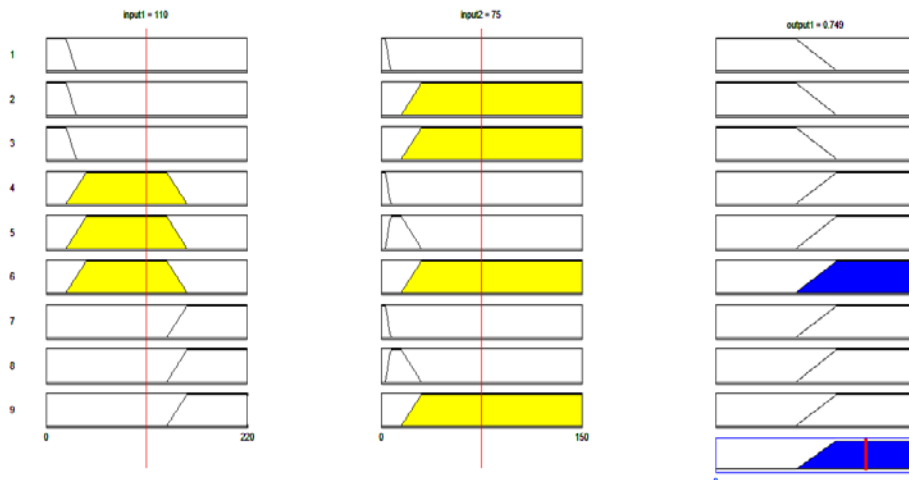

Fig. 13 Rule Viewer of Output Current

Both the input current are compare with fuzzy rules and give the output depends upon the rules.

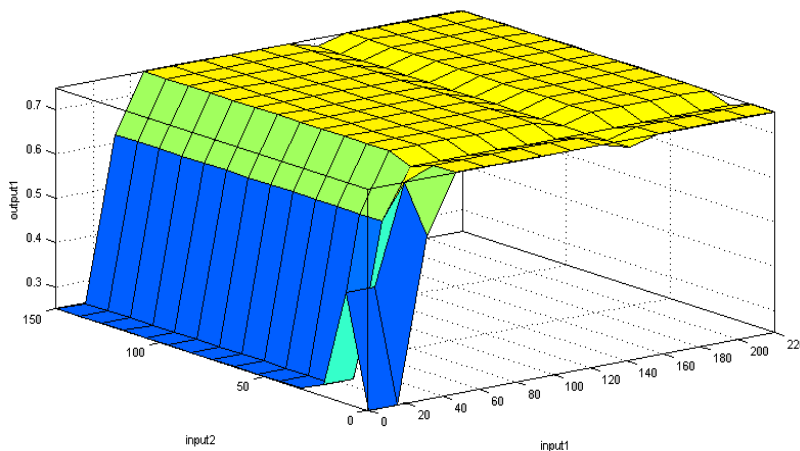

Fig. 14 Surface Viewer of Output Current

The Surface Viewer as shown Figure 14, three dimensional curves that represents the mapping from I_1 and I_2 . Because this curve represents a two input currents (I_1 and I_2) compares and shows one output depends upon fuzzy rules. Accordingly, the Surface Viewer is equipped with drop down menus X (input1), Y (input2) and Z (output).

V. RESULT ANALYSIS AND DISCUSSION

The Fuzzy Inference Based differential relays protect and isolate the transformer under different fault conditions using the circuit breakers. The developed system have rejection trip signal for external faults.

TABLE II RESULT ANALYSIS

S. No.	Operating Time (ms)	
	Existing System	Proposed System
AG	17	0.22
BG	17	0.22
CG	17	0.22
ABC	04	0.22

It is concluded from the above results the developed FLC with differential relay characterize a proper action to concern trip signal a large amount quicker than conventional relay. The existing system during an inner fault and neglect the mal function in external fault.

VI. CONCLUSION

FLC based differential relay for transformer has been analyzed and presented. The proposed system is performed with various fault conditions and it is concluded that the developed system under FLC performed better. FLC Based Differential Relay was intelligent to differentiate between inner faults and external faults. Simulation results show that fuzzy based differential relay is fast response in internal fault condition and more reliability. The inner and external faults are uninvolved; the detached phases are connected automatically based on reclosing incident. If formulate relay a novel safety device for transformer security and stability of supply.

REFERENCES

- [1] Ali Hooshyar, Majid Sanaye Pasand, Saeed Afsharnia, Mahdi Davarpanah, and Bashir Mahdi Ebrahimi, "Time Domain Analysis of Differential Power Signal to Detect Magnetizing Inrush in Power Transformer," *IEEE Transactions on Power Delivery*, Vol. 27, No. 3, July 2012.
- [2] Angle L. Orille Fernandez, Nabil Khalil Ghonaim, and Jaime A. Valencia, "A FIRANN as a Differential Relay for Three Phase Power Transformer Protection," *IEEE Transactions on Power Delivery*, Vol. 16, No. 2, April 2001.
- [3] Armando Guzman, Normann Fischer, and Casper Labus chagne, "Improvements in Transformer Protection and Control," *Inc. IEEE*, 2009.
- [4] CharlesMozina, Rama gokaraju Juan Carlos Garcia, "Turn to Turn Fault Detection in Transformers Using Negative Sequence Currents," *IEEE Transactions on Power Delivery*, Vol. 28, No. 3, July 2013.
- [5] Enio C. Segatto and Denis V. Coury, "A Differential Relay for Power Transformers Using Intelligent Tools," *IEEE Transactions on Power Systems*, Vol. 21, No. 3, August 2006.
- [6] C. Nagarajan, M. Madheswaran and D. Ramasubramanian, "Development of DSP based Robust Control Method for General Resonant Converter Topologies using Transfer Function Model," *Acta Electrotechnica et Informatica Journal*, Vol. 13, No. 2, pp. 18-31, April-June 2013
- [7] C. Nagarajan and M. Madheswaran, "DSP Based Fuzzy Controller for Series Parallel Resonant converter," *Springer, Frontiers of Electrical and Electronic Engineering*, Vol. 7, No. 4, pp. 438-446, Dec. 2012.
- [8] Thangaraju, M. Muruganandam and C. Nagarajan, "Implementation of PID Trained Artificial Neural Network Controller for Different DC Motor Drive," *Middle-East Journal of Scientific Research*, Vol. 23, No. 4, pp. 606-618, 2015.
- [9] Hamed Dashti, "Power Transformer Protection Using a Multi region Adaptive Differential Relay," *IEEE Transactions on Power Delivery*, Vol. 29, No. 2, April 2014.
- [10] Ivo Brncic, Zoran Gajic and Torbjorn Einarsson, "Transformer Differential Protection, Improved By Implementation of Negative Sequence currents", *ABB Power Technologies*, Sweden, 2007.
- [11] Jing Ma, Zen ping Wang, Qixun Yang and Yilu Liu, "Identifying Transformer Inrush Current Based on Normalized Grille Curve", April 2004.
- [12] Ljubomir A. Kojovic, Martin T. Bishop, and Dharma Sharma, "A New Algorithm to Identify Magnetizing Inrush Conditions Based on Instantaneous Frequency of Different Innovative differential Protection of Power Transformers Using Low Energy Current Sensors," *IEEE transactions on industry applications*, Vol. 49, No. 5, October 2013.
- [13] C. Nagarajan and M. Madheswaran, "Analysis and Simulation of LCL Series Resonant Full Bridge Converter Using PWM Technique with Load Independent Operation," in has been presented in *ICTES'08 a IEEE / IET International Conference* organized by M.G.R. University, Chennai, No. 1, pp. 190-195, Dec. 2007.
- [14] C. Nagarajan and M. Madheswaran, "Analysis and Implementation of LLC-T Series Parallel Resonant Converter with Fuzzy controller," *International Journal of Engineering Science and Technology (IJEST)*, *Applied Power Electronics and Intelligent Motion Control*, Vol. 2, No. 10, pp 35-43, December 2010.
- [15] C. Nagarajan, M. Muruganandam and D.Ramasubramanian, "Analysis and Design of CLL Resonant Converter for Solar Panel - Battery systems," *International Journal of Intelligent Systems and Applications (IJISA)*, Vol. 5, No. 1, pp. 52-58, 2013.
- [16] Manoj Tripathy, "Power Transformer Differential Protection Based on Neural Network Principal Component Analysis, Harmonic Restraint and Park's Plots," Vol. 36, April 2012.
- [17] Masoud Ahmadi pour, "Differential protection for power transformer using slant let transform and radial basis function," Vol. 2, No. 1, Feb. 2013.
- [18] Mohammad Hossein Zende del and Majid Sanaye Pasand, "Development of a Data Compression Index for Discrimination between Transformer Internal Faults and Inrush Currents," August 2009.
- [19] Nicola Chiesa, Bruce A. Mork and Hans Kristian Hoidal en, "Transformer Model for Inrush Current Calculations: Simulations, Measurements and Sensitivity Analysis," *IEEE Transactions on Power Delivery*, Vol. 25, No. 4, October 2010.
- [20] C. Nagarajan and M. Madheswaran, "Stability Analysis of Series Parallel Resonant Converter with Fuzzy Logic Controller Using State Space Techniques," *Taylor & Francis, Electric Power Components and Systems*, Vol. 39, No. 8, pp.780-793, May 2011.
- [21] M. O. Oliveira, "Application of Discrete Wavelet Transform for Differential Protection of Power Transformers," *IEEE Transactions on Power Delivery*, Vol. 20, No. 2, April 2005.
- [22] C. Nagarajan and M. Madheswaran, "Performance Analysis of LCL-T Resonant Converter with Fuzzy/PID Using State Space Analysis," *Springer, Electrical Engineering*, Vol. 93, No. 3, pp. 167-178, September 2011.
- [23] C. Nagarajan and M. Madheswaran, "Experimental Study and steady state stability analysis of CLL-T Series Parallel Resonant Converter with Fuzzy controller using State Space Analysis," *Iranian Journal of*

- Electrical & Electronic Engineering*, Vol. 8, No. 3, pp. 259-267, September 2012.
- [24] C. Nagarajan and M. Madheswaran, "Experimental verification and stability state space analysis of CLL-T Series Parallel Resonant Converter," *Journal of Electrical Engineering*, Vol. 63, No. 6, pp. 365-372, Dec. 2012.
- [25] L. Pei, O. P. Malik, G. S. Hope and G. Yong, "Improved operation of differential protection of power transformers for internal faults," *IEEE Transactions on Power Delivery*, Vol. 7, No. 4, October 2010.
- [26] Raju and K. Ramamohan Reddy, "Differential Relay Reliability Implement Enhancement of Power Transformer," Vol. 2, No. 5, pp. 3612-3618, Sep.-Oct. 2012.
- [27] Rekina Fauad, "Transformer Differential protection scheme internal faults detection algorithm second harmonics restrain and fifth harmonics blocking logic," April 2012.
- [28] Saeed Afsharnia and Majid Sanaye Pasand, "A New Algorithm to Identify Magnetizing Inrush Conditions Based on Instantaneous Frequency of Differential Power Signal," *IEEE Transactions on Power Delivery*, Vol. 25, No. 4, October 2010.
- [29] S. A Saleh and M. A. Rahman, "Modelling and Protection of a Three Phase Power Transformer Using Wavelet Packet Transform," *IEEE Transactions on Power Delivery*, Vol. 20, No. 2, April 2005.
- [30] T. Zheng, J. Gu, S. F. Huang, F. Guo, and V. Terzija, "A New Algorithm to Avoid Mal operation of Transformer Differential Protection in Substations With an Inner Bridge Connection," *IEEE Transactions on Power Delivery*, Vol. 7, No. 4, October 1992.